

Parts List



File No.

Air Conditioner

INDOOR UNIT
KHS1271

Model No.	Prod.Code	Volt-Phase-Hertz
KHS1271	1 852 099 80	115-1-60

KHS1271
INDOOR UNIT

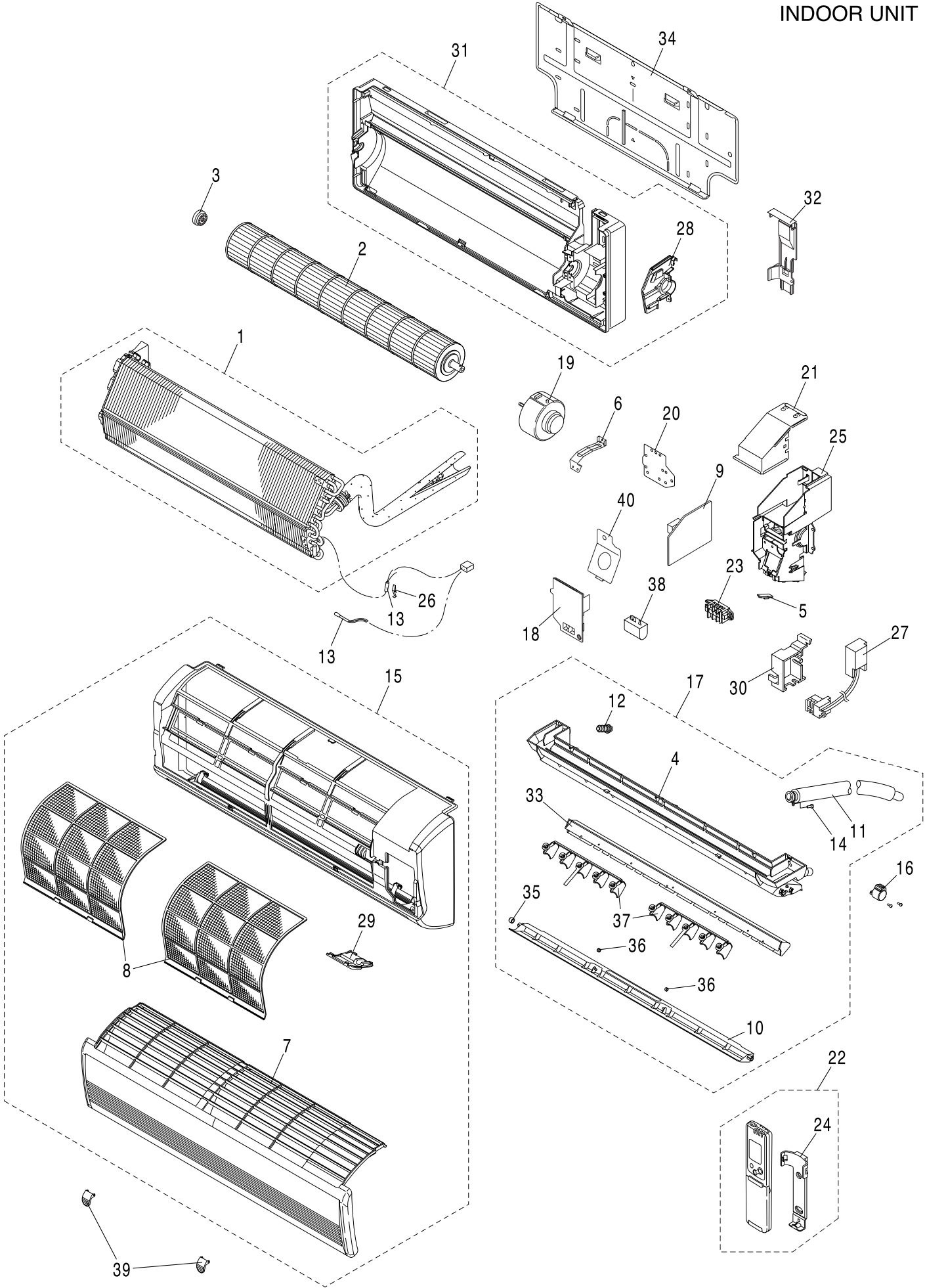

ATTENTION !

To ensure correct parts supply, please let us know followings,
when you make service parts order:

1.Part No. 2.Description 3.Q'ty 4.Volts-Hz-Ph 5.Product Model No.

KHS1271
INDOOR UNIT

Key No.	Part No.	Description	Q'ty	Reference No.
1	623 190 8320	Evaporator Ass'y	1	852-0-4116-92800
* 2	623 184 7018	Cross-Flow Fan Ass'y	1	852-0-2509-29300
* 3	623 171 8318	Bearing Housing Ass'y	1	852-0-2510-13200
4	623 190 8313	Air Outlet Frame	1	852-2-1531-20711
* 5	623 190 8306	P.C.B. Ass'y IND-KHS1271	1	8FA-0-5178-55900
6	623 177 2150	Mounting Plate	1	852-2-2309-97501
7	623 190 8290	Ornamental Plate	1	852-2-1516-38051
8	623 190 8283	Air Filter Ass'y	2	852-0-2307-34002
* 9	623 190 8528	Circuit Board Ass'y CB-KHS1271	1	8FA-0-5181-17100
10	623 190 8344	Flap	1	852-2-1523-29211
11	623 177 2235	Drain Hose Ass'y	1	852-0-1303-29400
12	623 171 8363	Cap, Drain Pan	1	852-2-2348-12401
* 13	623 178 2456	Thermistor Ass'y PTM-D51H-S3	1	8FA-0-5259-05100
14	623 171 9001	Screw Special	1	852-2-2396-15901
15	623 190 8337	Grille Ass'y	1	852-0-1501-74700
* 16	623 177 2204	Step Motor MP24Z3-12V	1	1FA-4-M3A0-00900
17	623 190 8405	Air Outlet Ass'y	1	852-0-1531-30500
18	623 190 8399	Terminal Cover	1	852-2-5321-20311
* 19	623 190 8382	Fan Motor IBH-884-076	1	1FA-4-M1A0-11301
20	623 190 8375	Mounting Plate	1	852-2-2385-14701
21	623 184 2969	Plate,Elec.Component Box	1	852-2-5309-40901
* 22	623 190 8368	Remote Control Switch RCS-4HVPIS4U	1	8FA-0-0054-29100
23	623 003 2996	Terminal Base KTU15N-3J	1	4-2379-56159
24	623 171 8400	Holder	1	851-2-5377-02001
25	623 190 8467	Elec. Component Box	1	852-2-5307-70001
26	623 148 5876	Mounting Thermostat SUS301-CSP	1	852-2-5303-22401
* 27	623 185 8816	Minus Ion Generator ION-YU11-1S3	1	1FA-4-P1Z0-05900
28	623 190 8450	Mounting Plate	1	852-2-2309-78511
29	623 190 8443	Sash ORN Ass'y	1	852-0-1301-31300
30	623 190 8436	Mounting Plate	1	852-2-2385-12011
31	623 190 8429	Frame Ass'y	1	852-0-2201-43500
32	623 190 8412	Mounting, Tube	1	852-2-2362-29812
33	623 190 8511	Guide Air Defl	1	852-2-2360-19411
34	623 177 2433	Rear Panel	1	852-2-2230-22501
35	623 146 9104	Mounting	1	852-2-1514-52001
36	638 003 7209	Mounting	2	852-2-1514-44002
37	623 190 8504	Blade	2	852-2-1519-34911
* 38	623 190 8498	Fixed Capacitor 250V/4.5MF	1	1FA-4-C1A0-40000
39	623 190 8481	Cap	2	852-2-2350-23811
40	623 190 8474	Angle Terminal	1	852-2-5306-36101

NOTE: Metal and plastic parts will be supplied basically with necessary heat insulation pads or packing.
Each key number with an asterisk (*) means the recommended service parts.



SANYO Electric Co.,Ltd
Osaka, Japan
12/05 Printed in Japan